

#273514 HWLSD-5

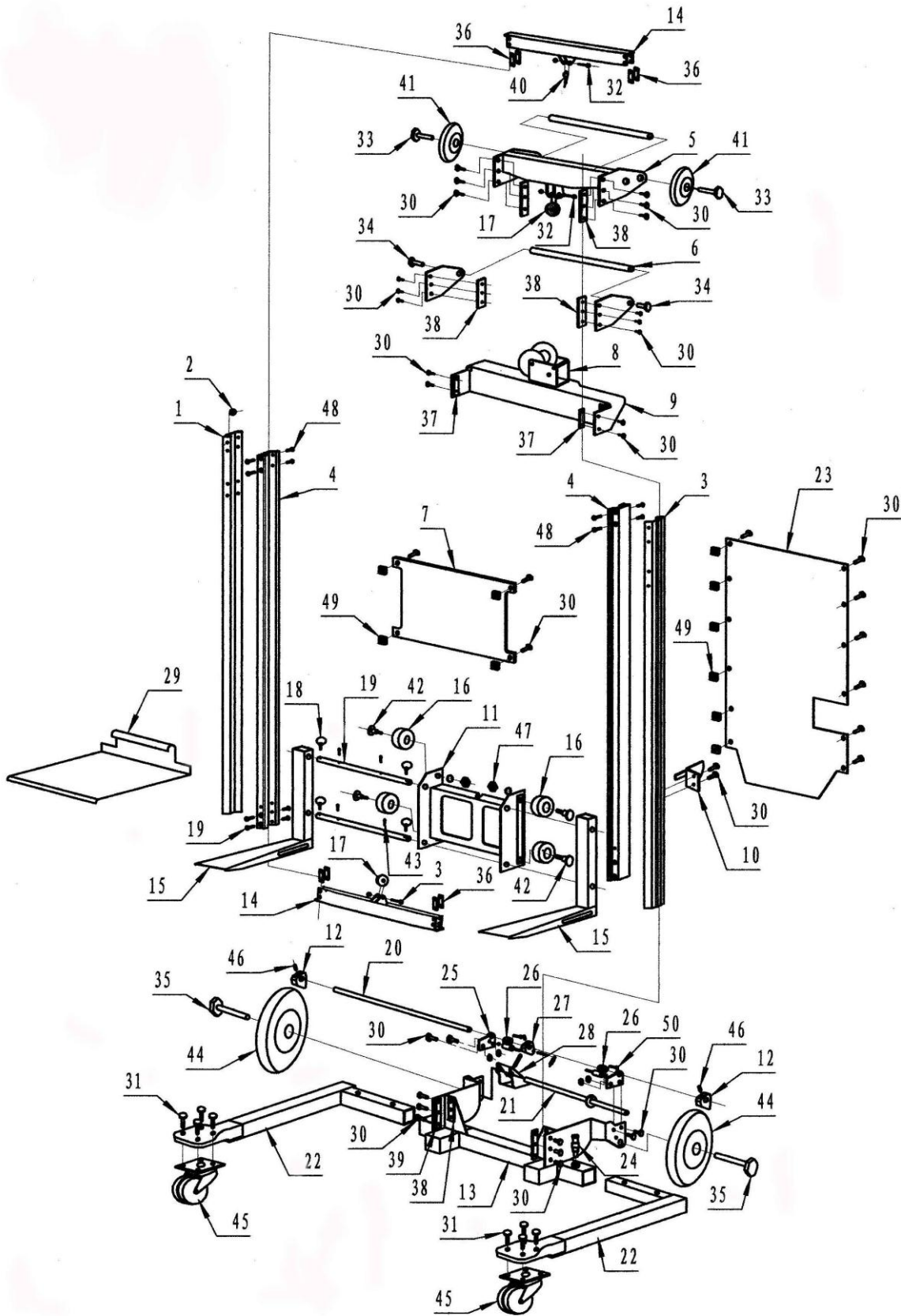

WESCO #	Ref. No.	Description	Qty.
	1	Left Mast Frame	1
	2	Gasket	30
	3	Right Mast Frame	1
	4	Inner Frame	2
	5	Up Support Frame Assembly	1
	6	Operator Handle	1
	7	Decal Plate	1
273547	8	Manual Winch	1
	9	Winch Mounting Support Bracket	1
	10	Limit Position Assembly	1
273536	11	Carriage	1
	12	Brake block	2
	13	Base Assembly	1
	14	Beam	2
273538	15	Fork	2
	16	Roller Wheel	4
273531	17	Upper and Lower Pulley	3
273546	18	Fork Lock Pin	4
273537	19	Carriage Crossbars	2
	20	Brake Shaft	1
	21	Pedal Shaft Assembly	1
	22	Standard Support Legs	2
	23	Baffle Plate	1
273540	24	Spacer Pin	2
	25	Brake Shaft Support Plate	2
	26	Brake Locating Assembly	2
	27	Brake Adjustment Block	1
	28	Pedal Assembly	1
273518	29	Deck Platform(option)	1
	30	Hexagon Headed Bolt M6x12	38
	31	Hexagon Headed Bolt M8x25	8
273532	32	Hexagon Headed Bolt M10x60	3
	33	Hexagon Headed Bolt M12x70	2
	34	Hexagon Headed Bolt M12x25	2
	35	Hexagon Headed Bolt M14x90	2
	36	Fastness Plate(short)	8
	37	Fastness Plate	2

	38	Fastness Plate(long)	6
	39	Elongated Fastness Plate	2
	40	Cable Ring	1
273530	41	Loading Wheels 4"	2
	42	Roll Wheel Central Spindle	4
	43	Spring Pin	4
273545	44	Mold-on Wheel 8"	2
273541	45	Caster ddd2"	2
	46	Holding Screw M8x12	2
	47	Hexagon Nut M10	4
	48	Flat Head Screw M6x20	16
	49	Square Nut M6	16
	50	Hexagon Headed Bolt M6x35	2

273552 NOT SHOWN CABLE: 500 LBS

1

