

REMOVABLE PLASTIC HANDLE

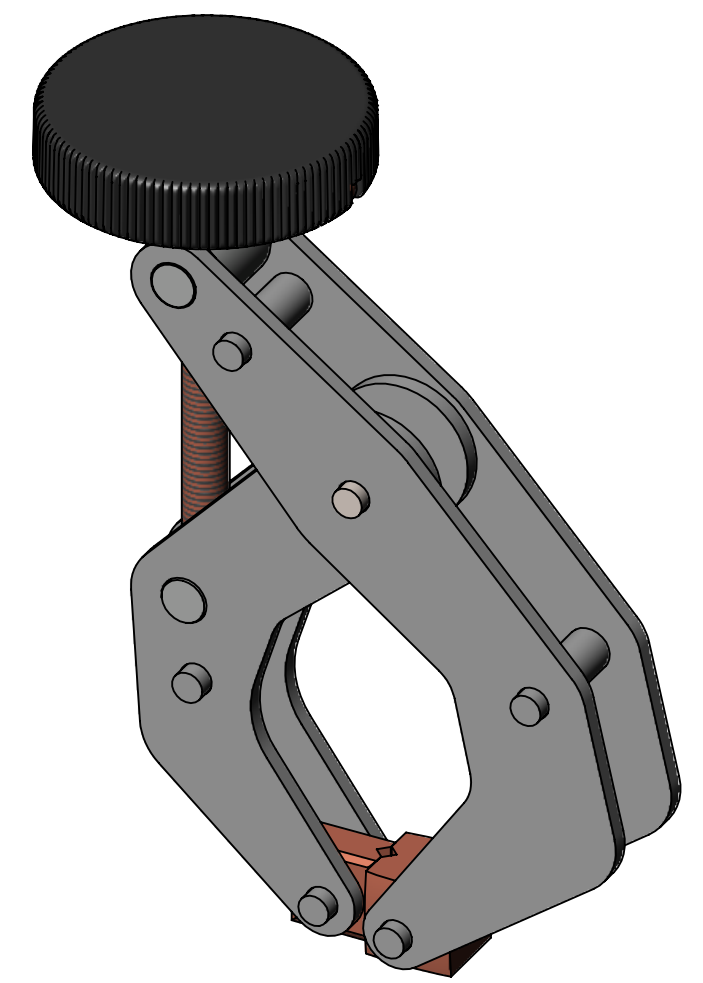
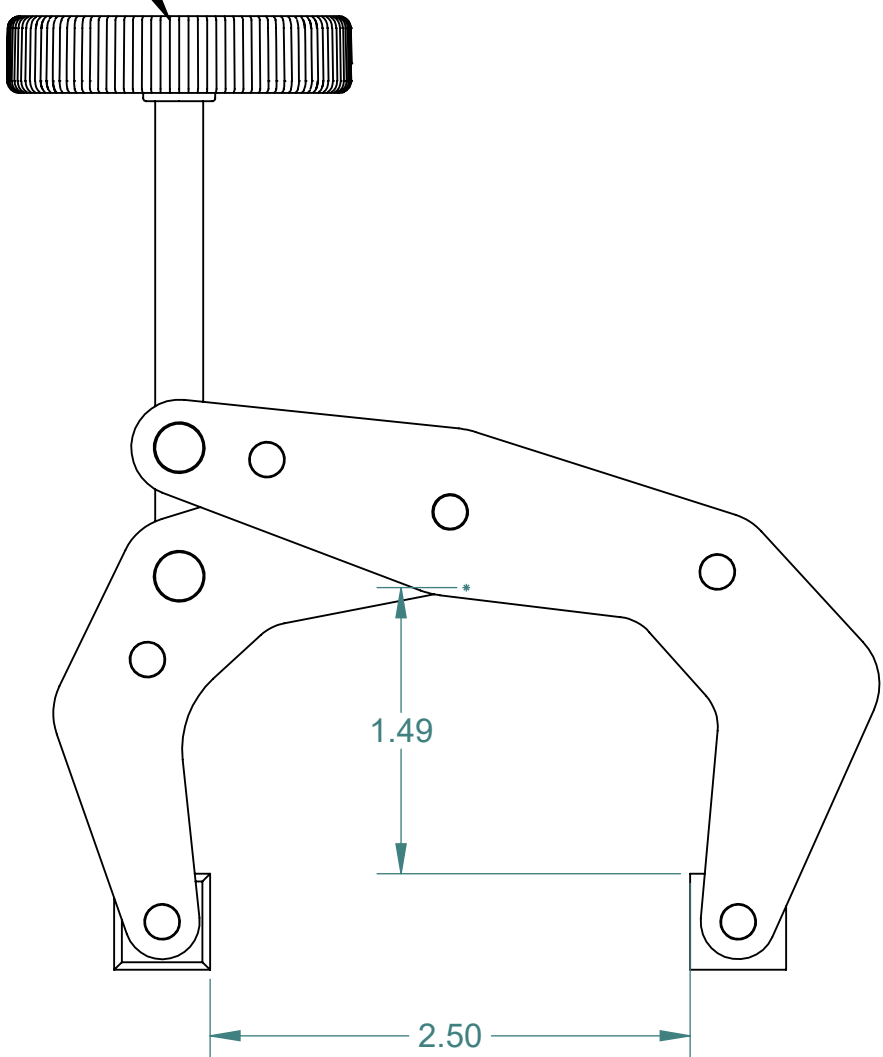
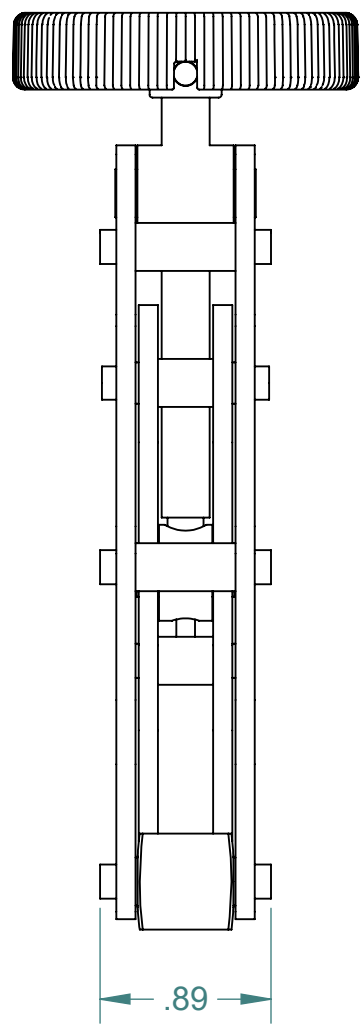

APPROXIMATE WEIGHT: 0.54 LBS

ALL DIMENSIONS ARE IN INCHES EXCEPT AS NOTED. B SIZE - SHEET 1 OF 1

This drawing and all of the elements thereof, including the design and principles of construction disclosed, is the sole and exclusive property of Industrial Magnetics, Inc. and is being submitted by Industrial Magnetics, Inc. for the limited purpose of assisting the designated recipient to evaluate the services of Industrial Magnetics, Inc. This drawing may not be used for any other purpose, nor may it be copied, reproduced, loaned, transferred, or communicated to any other person, either verbally or in writing, without the written consent of Industrial Magnetics, Inc.



TOLERANCES EXCEPT AS NOTED DECIMAL .00"=±.030" ANGULAR ±1° .000"=±.015"	RELEASED DATE	R & D	DESCRIPTION
	DRAWN BY N.SKRZYPCZAK	SCALE FULL	KANTTWIST 2" CLAMP ROUND WEAVER GRIP
	RELEASED BY	DATE 10/12/2023	PART NO. K020R
			DRAWING NO. 24124