

# Mitutoyo

Mitutoyo Quality

## High-End CNC Rockwell Hardness Testing Machine HR-600 Series

Test Equipment and Seismometers

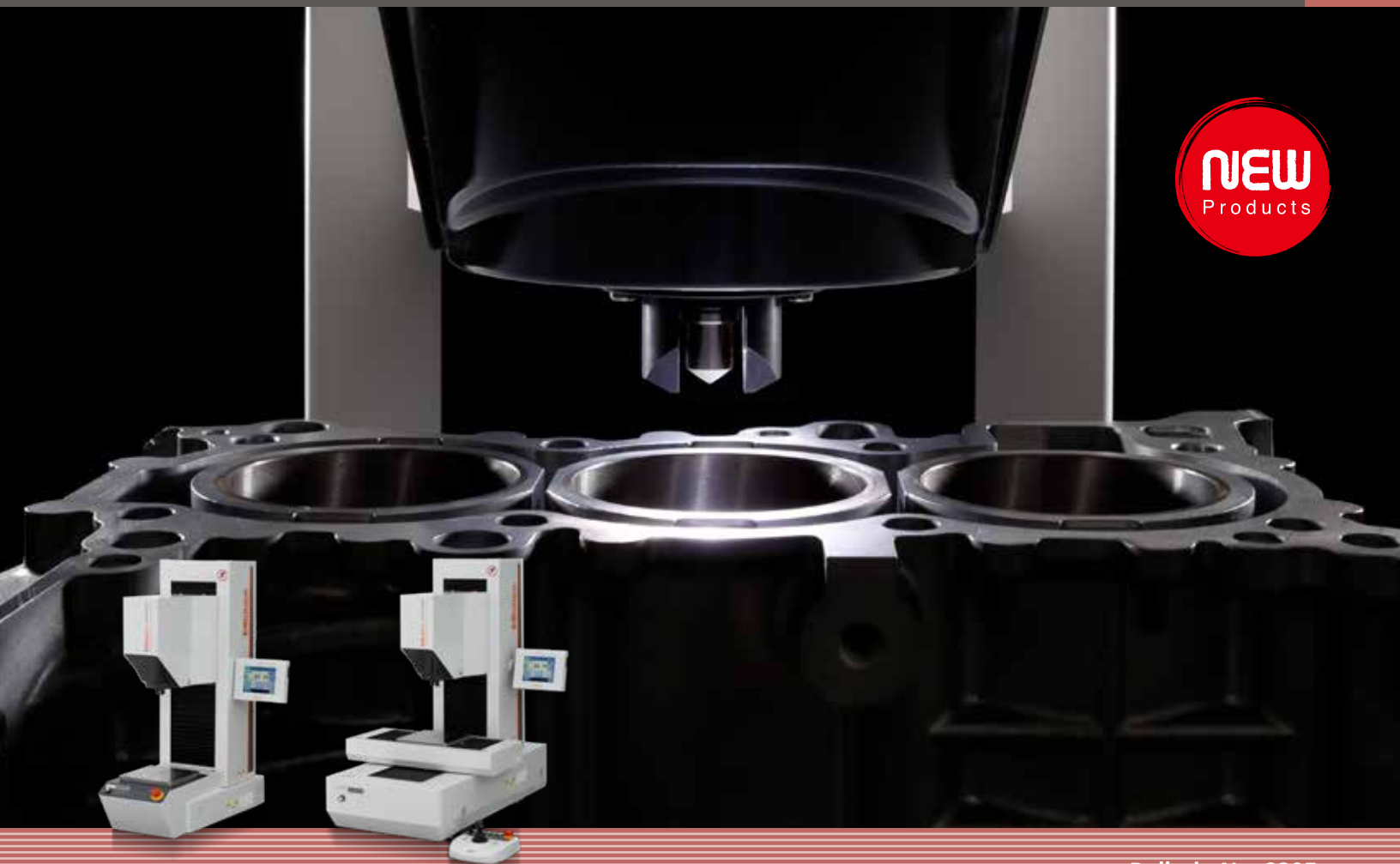

Bulletin No. 2295

Go above and beyond.

# HR-600 SERIES

High-End CNC Rockwell Hardness Testing Machine

With innovative design and functionality that enables a wide variety of measurements, the HR-600 Series delivers hardness testing that defies conventional thinking.

The HR-600 Series combines the functionality of two previous models: one for Rockwell hardness testing and the other for Light Force Brinell hardness testing. Supporting both test types on a single machine, this new series expands the range of available measurements.

With its high-resolution scale load cell developed uniquely by Mitutoyo that allows for high-precision test load feedback control and state-of-the-art design that delivers both aesthetics and usability on the ground, the new HR-600 Series enables hardness testing that defies conventional thinking.





# LINE-UP



## HR-610A

Standard Rockwell hardness testing machine model with moving head

**Maximum table loading** 100 kg  
**Maximum workpiece height** 250 mm  
**Depth (from indenter center)** 220 mm  
**Test force** 29.42 - 1839 N (3 - 187.5 kgf)



## HR-620A

Rockwell hardness testing machine with high added value that can measure micro-Brinell hardness and the hardness of plastics

**Maximum table loading** 100 kg  
**Maximum workpiece height** 250 mm  
**Depth (from indenter center)** 220 mm  
**Test force** 9.807 - 2452 N (1 - 250 kgf)

## HR-620B

Fully automatic multi-point Rockwell hardness testing machine with Y-axis stage mobility that can measure micro-Brinell hardness and the hardness of plastics, and also supports multi-point inspection

**Maximum table loading** 100 kg  
**Maximum workpiece height** 250 mm (with X-axis stage: 165 mm)  
**Depth (from indenter center)** 220 mm  
**Test force** 9.807 - 2452 N (1 - 250 kgf)

## Supports Rockwell and Light Force Brinell hardness testing on a single machine. Focused on usability on-the-ground.

The HR-600 Series, in addition to a standard Rockwell hardness testing model, offers machines with high added value that can test micro-Brinell hardness and the hardness of plastics as well, and also a lineup of models with Y-axis stage mobility that support fully automatic multi-point Rockwell hardness testing. Its key focus is on usability on the ground, where a wide range of materials — from metals to plastics — may need to be tested.

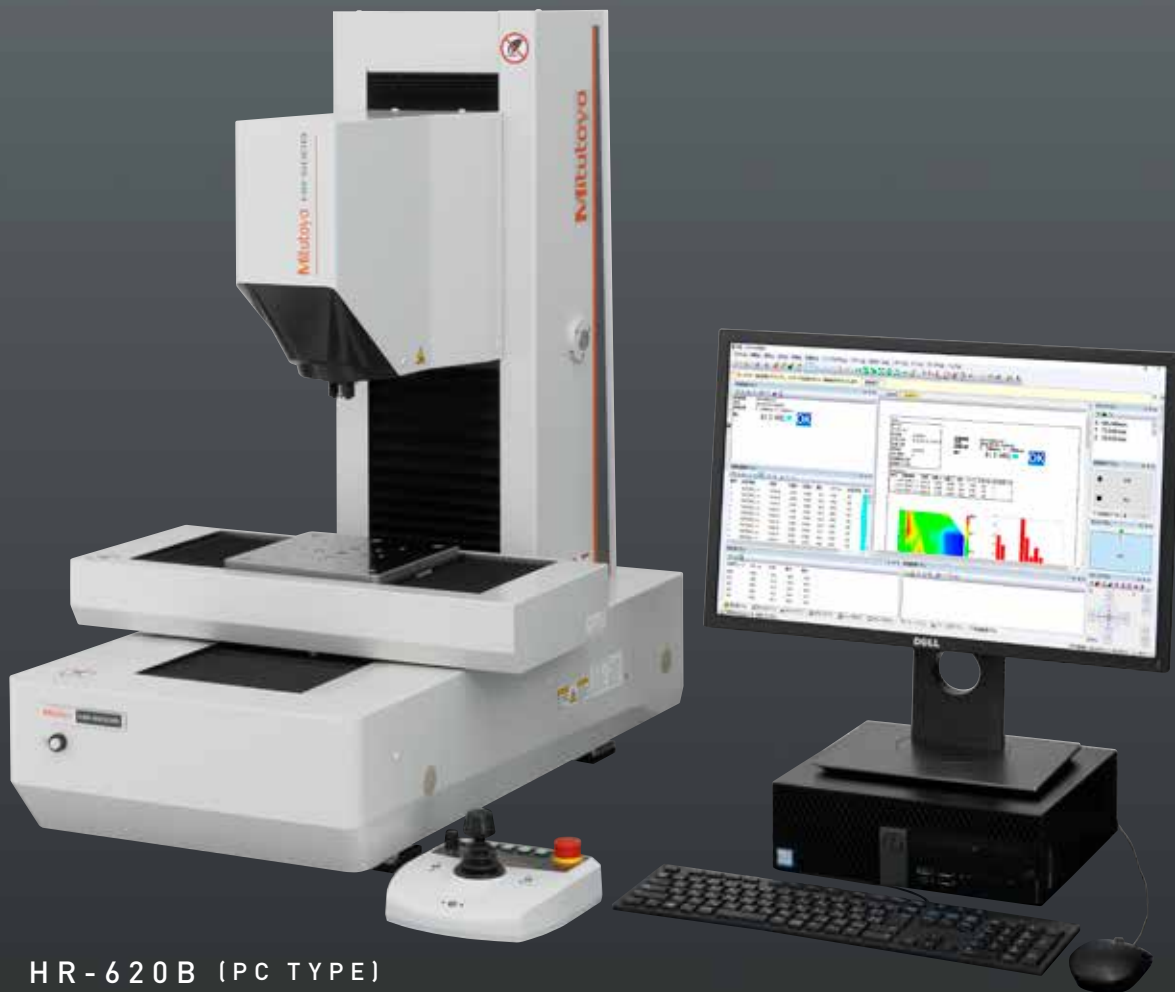

### HR-620B (PC TYPE)

The PC TYPE model allows users to view measurement data on large-screen PC monitors  
Other features are the same as HR-620B

**Maximum table loading** 100 kg  
**Maximum workpiece height** 250 mm (with X-axis stage: 165 mm)  
**Depth (from indenter center)** 220 mm  
**Test force** 9.807 - 2452 N (1 - 250 kgf)

Note: HR-620B in above photo shown with X-axis stage (optional) installed.

# DESIGN

## New design with functional beauty

With a table for mounting workpieces and head with vertical mobility, the HR-600 Series is built for operability and usability. Its new design is highly focused on end-user usability, and the entire product structure has been inventively modified for functional beauty — a true embodiment of Mitutoyo's pioneering spirit.

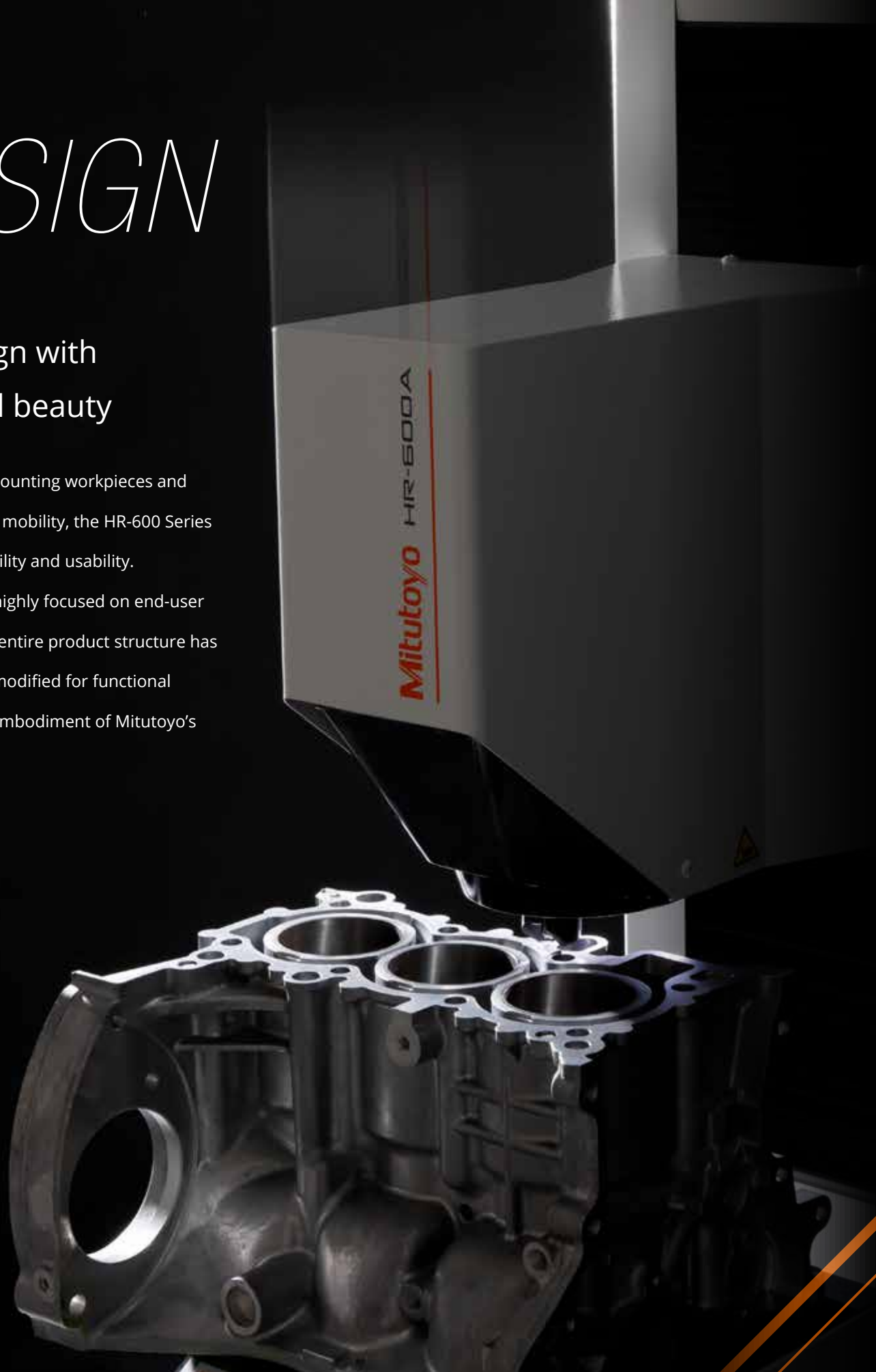

# Design that pushes the boundaries of measurement diversity

## First Mitutoyo hardness testers with moving heads



First Mitutoyo hardness testers ever to be equipped with moving heads (the head moves at a speed of 10 mm/s within a 210 mm range).

**210 mm**  
Movement along Z-axis [drive unit]

**10 mm/s**  
Speed along Z-axis [drive unit]

## Larger tables expand the range of measurements



Tables were too small and lacked depth; large workpieces could not be mounted or measured.

**Maximum loading** 20 kg  
**Depth (from indenter center)** 150 mm



HR-600 series

Tables are bigger and have more depth, allowing large workpieces to be mounted and measured as is.

**Maximum loading** 100 kg  
**Depth (from indenter center)** 220 mm

## Large workpieces can be mounted easily



Large workpieces such as cylinder blocks can be mounted on the table as is. Testing of heavy workpieces weighing up to 100 kg is supported.

# WORKPIECE

---

Supports testing of a wide range of workpiece, from metals to plastics

The HR-600 Series can test a wide variety of workpiece, ranging from those made of metal (crankshafts, cylinder blocks, etc.) to softer workpieces (brake pads, plastic parts, etc.), and supports both Rockwell and Light Force Brinell hardness testing on a single machine.



### Crank shaft



The head moves vertically during testing to avoid colliding with the workpiece. Installing a sliding jig onto the fixed stage allows for efficient testing.

### Plastic parts

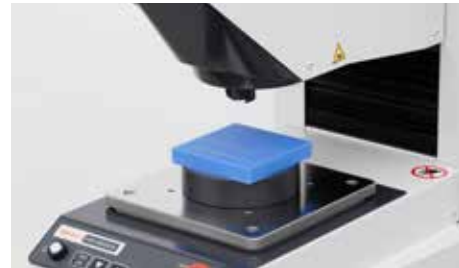

Allows users to set sequences as required by the standards for testing plastic hardness (i.e. applying, maintaining, and removing the test load, and then reading the hardness value).

### Cylinder head



Large and heavy cylinder heads that were difficult to measure using hardness testers with elevating tables can now be mounted and measured on a fixed stage.

### Gear



Post-heat treatment hardness of multiple parts of gears (tooth flank, face and tip, etc.) can be tested.\*

### Cylinder block



Large and heavy cylinder blocks that were difficult to measure using hardness testers with elevating tables can now be tested by mounting them on a fixed stage.

### Brake pads



Supports HRR and HRS, which use ball indenters, and other scales as well.\*

\* Models providing Y-axis stage mobility (for multi-point testing of a single specimen and simultaneous testing of multiple specimens) and X-axis stages (optional) also available.

# USABILITY

---

## Enhanced usability and operability effectively reduce measurement/analysis time

The display screen lets you view test results on the spot. You can choose from five displays (see page 11), according to what you need to view. The screens are touch-screen enabled to deliver excellent usability.

The HR-600 Series also offers many features useful for measurement and analysis, such as those that allow the user to directly select the hardness scale of their choice and statistical analysis features that can help them analyze multiple test results. Its enhanced usability will streamline your workflow by reducing measurement and analysis time and in other ways as well.





**Standard operating display**

Displays test results and conditions. All information can be viewed on a single screen.



**Simple display**

Displays test results and scales only, and provides an at-a-glance view of test conditions, making it suitable for tests that are repeated under the same conditions.



**Multi-point test display**

Navigation feature informs users of set test points. Users can perform multi-point tests, such as the Jominy test, through simple operations.



**List display (mean value)**

Displays the mean hardness value averaged over multiple points arbitrarily specified. The average of five test results is displayed in large font.

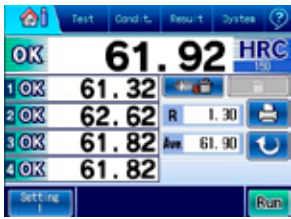

**List display (5-point display)**

Displays the five most recent test results in list format. Suited for checking the order and average values of test results, and also variations in the results.



**Direct hardness scale selection**

Users can directly select the hardness scale (determined by the test force and indenter) of their choice from the touch screen. The initial test force and total test force are automatically set according to the selected scale.



**Curved surface compensation feature**

The curved-surface correction function enables curved surfaces, such as round bars and concave or convex shapes, to be tested for hardness as easily as flat surfaces.



**Statistical analysis**

Quality management decisions based on hardness testing of industrial materials are made using multi-point test results. The statistical analysis feature, which can calculate the maximum, minimum, average, standard deviation and other values, is useful for analyzing multi-point test results.



A touch screen that can toggle between different views enables excellent control of a rich palette of features.

# SOFTWARE AVPAK V3

Enables smooth and efficient measurements

AVPAK, using part programs, enables automated multi-point testing in the X-, Y- and Z-axis directions.

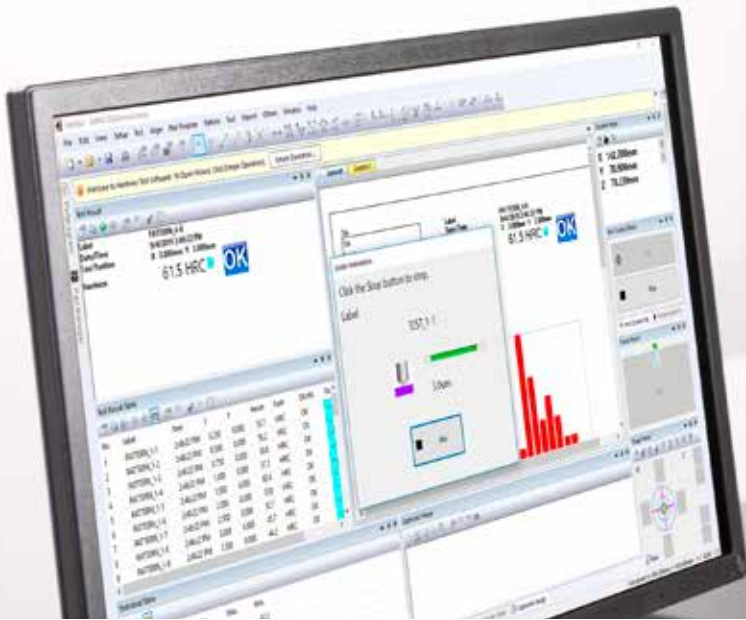

## Other software

For display unit type  
EXPAK  
<Data Processing Software>



Software you can use to create test reports, perfect for evaluating hardened layers in steel alloys. Equipped with a two-dimensional distribution visualization feature useful for evaluating work hardening and residual stress.

U-WAVE  
<Measurement Data Wireless Communication System>

With the U-WAVE system, you can wirelessly send and import measurement data to commonly used software (Excel, notepad, etc.).

AVPAK (Optional)  
FORMEio  
<External Communication Program>

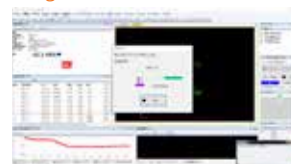

Software that enables external control of measuring instruments through PLC, allowing users to control them and monitor their status via RS-232C or LAN communication.

Note: FORMEio upgrades for AVPAK compatibility also available (V4.0 and later).

MeasurLink  
<Measurement Data Network System>



An IoT platform that visualizes quality by collecting data from measuring instruments in real time and then centrally managing and statistically processing this data.

# AUTOMATION

## Build a system that caters to the needs on the ground

By installing an X-axis stage on an HR-620B machine and creating a system that coordinates with robots, you can automate the testing procedure, from mounting workpieces to sorting them according to test results.



Example of Rockwell hardness testing machine automation on a production line

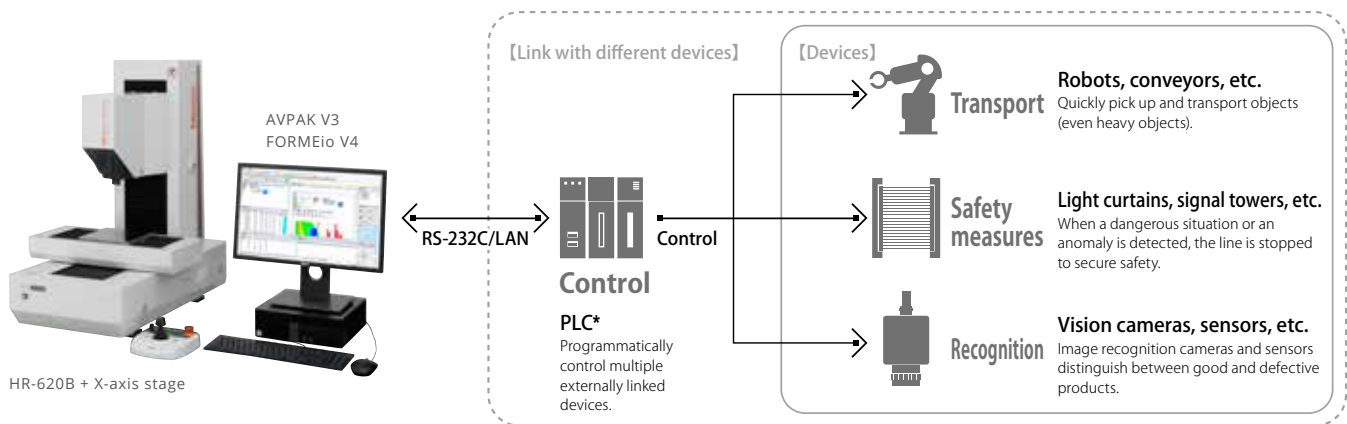

\* Programmable Logic Controller

# OPTION

Enables testing of a wide range of materials and supports special tests as well.

We offer useful items such as PCs for remote operation software and V-anvils for round workpieces.

The HR-600 Series supports testing of a wide range of materials — from hard metals to thin, soft plastics — and also special tests, such as simultaneous testing of multiple materials.



## Testing machine rack A

Rack for standard-type HR-610A/HR-620A models.



**Number of casters:** 4  
**Dimensions (W×D×H):** 760×560×642 mm

## Display unit

Touch screen enabled color display with a rich choice of features. Standard accessory for HR-610A and HR-620A; special accessory for HR-620B.



## Control software AVPAK

Software that controls tests and handles their status and results, all as one consistent workflow.



## Testing machine rack B

Rack for HR-620B.



**Number of casters:** 4  
**Dimensions (W×D×H):** 910×820×642 mm

## X-axis stage

Two models, each with a different stage moving range (160 mm and 300 mm), are available.



**Maximum loading:** 50 kg

## V-anvil

For testing round specimens.



**Minimum diameter:**  $\varnothing$ 20 mm  
**Maximum diameter:**  $\varnothing$ 55 mm



### Contactor (large)

Used with  $\phi 5$  mm,  $\phi 10$  mm,  $\phi 1/4$  in., and  $\phi 1/2$  in. indenters.



### Carbide ball indenters (Brinell)

Four models ( $\phi 1$  mm,  $\phi 2.5$  mm,  $\phi 5$  mm, and  $\phi 10$  mm) for Brinell/HBT\* hardness testing.



\* Brinell depth measurement

### Digimatic Mini-Processor DP-1VA LOGGER

Small portable printer for statistical analysis and printing measurement data. Can store up to 1,000 pieces of data using its data logger feature. Can be connected to a PC using USB cable.



### Digimatic Gage/PC Data Input Device USB Input Tool Direct USB-ITN

Simply connect to your PC to import measurement data to Excel, notepad, etc.



### Measurement Data Wireless Communication System U-WAVE

Lets you easily import measurement data to your PC via wireless communication.



### Foot switch

Enables operator to start test sequence while keeping both hands free.



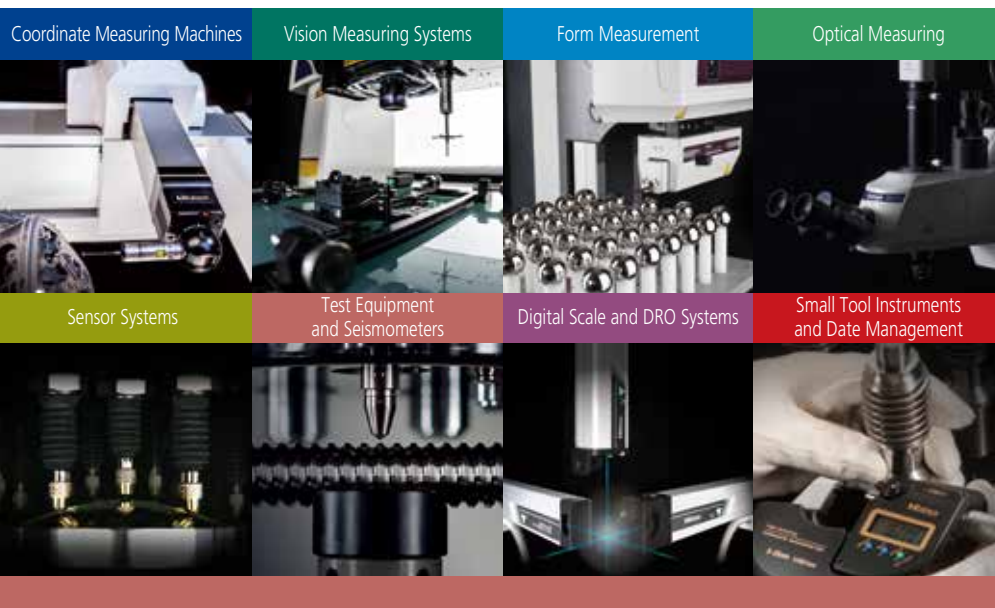

**Whatever your challenges are, Mitutoyo supports you from start to finish.**

Mitutoyo is not only a manufacturer of top-quality measuring products but one that also offers qualified support for the lifetime of the equipment, backed by comprehensive services that ensure your staff can make the very best use of the investment.

Apart from the basics of calibration and repair, Mitutoyo offers product and metrology training, as well as IT support for the sophisticated software used in modern measuring technology. We can also design, build, test and deliver measuring solutions and even, if deemed cost-effective, take your critical measurement challenges in-house on a sub-contract basis.



**Find additional product literature and our product catalog**

[www.mitutoyo.com](http://www.mitutoyo.com)

**Note:** All information regarding our products, and in particular the illustrations, drawings, dimensional and performance data contained in this printed matter as well as other technical data are to be regarded as approximate average values. We therefore reserve the right to make changes to the corresponding designs. The stated standards, similar technical regulations, descriptions and illustrations of the products were valid at the time of printing. In addition, the latest applicable version of our General Trading Conditions will apply. Only quotations submitted by ourselves may be regarded as definitive. Specifications are subject to change without notice.

Mitutoyo products are subject to US Export Administration Regulations (EAR). Re-export or relocation of our products may require prior approval by an appropriate governing authority.

**Trademarks and Registrations**

Designations used by companies to distinguish their products are often claimed as trademarks. In all instances where Mitutoyo America Corporation is aware of a claim, the product names appear in initial capital or all capital letters. The appropriate companies should be contacted for more complete trademark and registration information.

# Mitutoyo

**Mitutoyo America Corporation**

[www.mitutoyo.com](http://www.mitutoyo.com)  
 One Number to Serve You Better  
 1-888-MITUTOYO (1-888-648-8869)

**M<sup>3</sup> Solution Centers:**

- Aurora, Illinois (Headquarters)
- Boston, Massachusetts
- Charlotte, North Carolina
- Cincinnati, Ohio
- Detroit, Michigan
- Los Angeles, California
- Birmingham, Alabama
- Seattle, Washington
- Houston, Texas